

You will need:

- 2 x 60 cm lengths of 10 cm wide e.g. tough, non-stretch material such as deck chair canvas
- 10 x 10 cm square of material to make a pocket for the battery holder
- 2 x AA (1.5 V) batteries and a holder
- 2 x 22 Ω (22R) resistors
- 50 Ω (50R) variable resistor
- 2 x 60 cm lengths of Velcro®
- 5 cm x 1 cm strip of *ElectroLYcra* [1]
- voltage sensor
- Two 6 cm x 3.2 cm lengths of elastic [2].

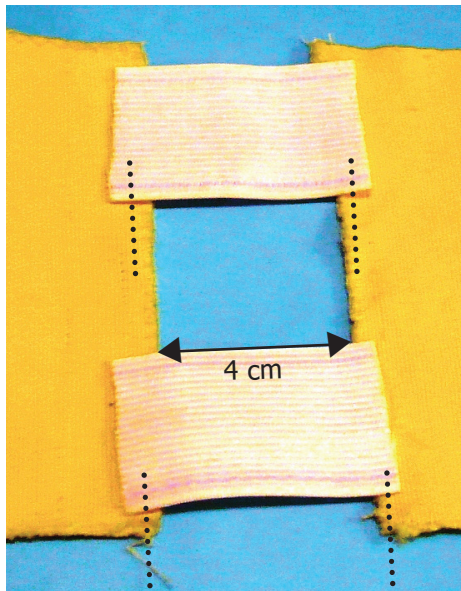

Figure 1 - Place the 2 strips of fabric 4 cm apart and stitch the elastic to it.

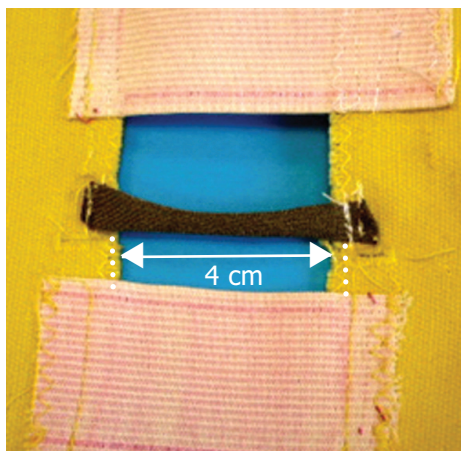

Figure 2 - Place the *ElectroLYcra* between the 2 pieces of material and stitch together.



Figure 3 - Insert one jaw of the croc clip through the buttonhole.

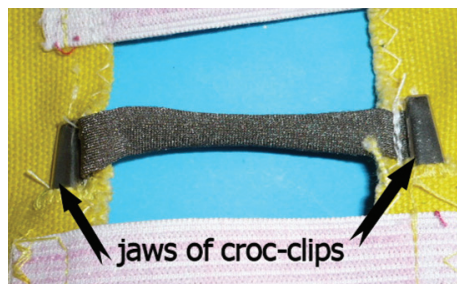

Figure 4 - Ensure the croc clips grip the *ElectroLYcra*.

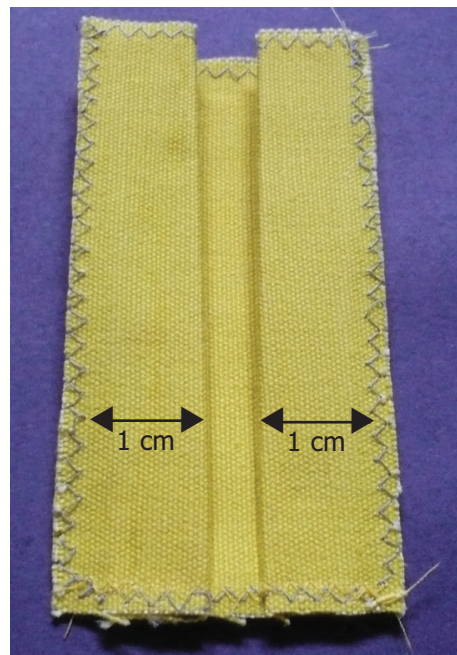

Figure 5 - Fold the material as shown.

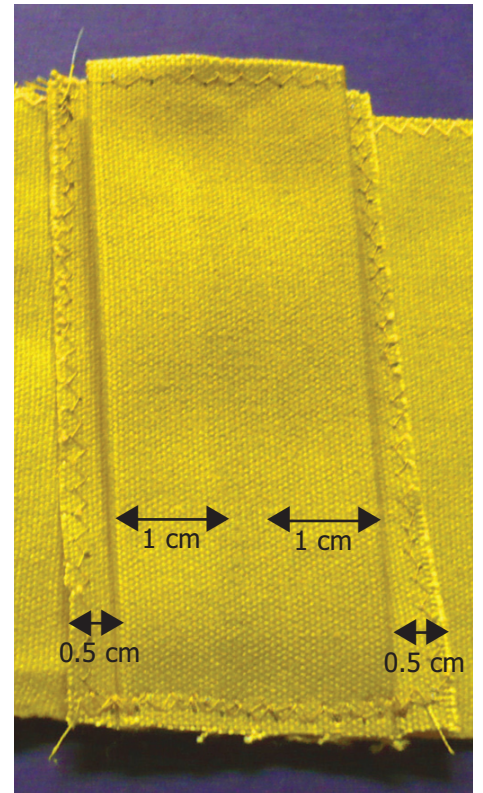

Figure 6 - Stick the pocket in place as indicated.

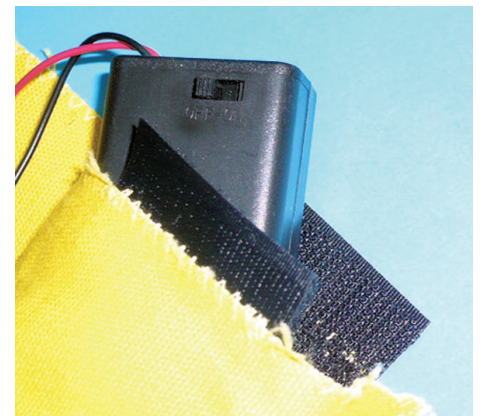

Figure 7 - Stick the pocket in place as indicated.

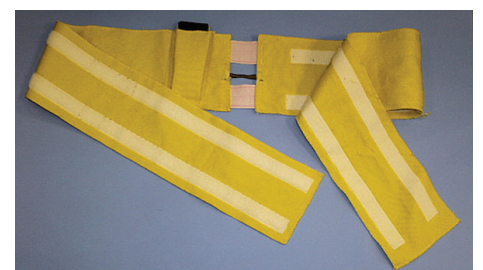

Figure 8 - Strips of Velcro on top on one side and underneath on the other side.

Lay the two strips of material out with a gap of 4 cm between each piece (Figure 1). Place one strip of elastic at the top of the gap and the other at the bottom of the gap. Sew the elastic to the material using a straight stitch as indicated by the dashed lines in Figure 1. Place the strip of ElectroLycra across the centre of the gap and sew it to either side of the gap with a straight stitch as indicated by the dashed lines in Figure 2, ensuring there is a 4 cm piece of ElectroLycra free across the gap. Just under the ElectroLycra make a buttonhole each side 0.5 cm in length for one jaw of the croc clip to fit through, see Figure 3, ensuring the croc clip will close holding the ElectroLycra on the other side, see Figure 4.

Make a pocket to take the battery holder using the 10 cm square of material and taking a 1 cm tuck at each side leaving 0.5 cm for the seam, see Figure 5, and stitching it to the belt 4 cm from the gap with the ElectroLycra with the tucks facing the belt, as shown in Figure 6. Attach a 4 cm strip of Velcro to the top of each side of the top of the pocket, see Figure 7, so they will stick together and prevent the battery holder from

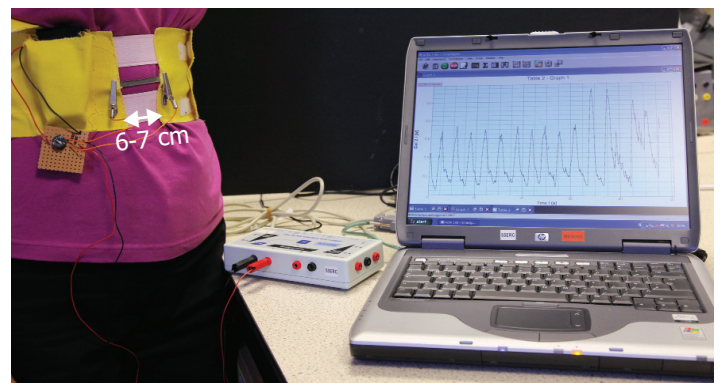

Figure 11 - Ensure ElectroLycra operates in stretching range of 6-7 cm. A typical set of results are shown.

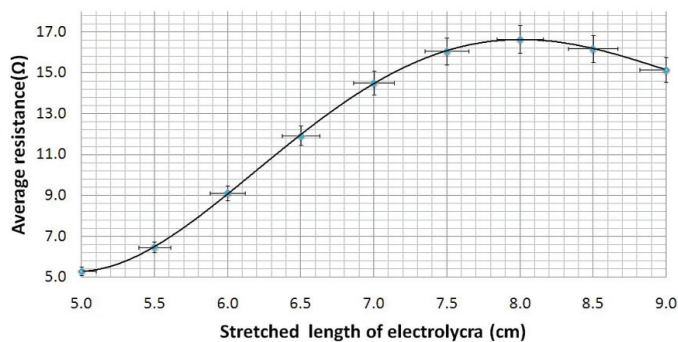

Figure 9 - Change in resistance of a 5 cm strip of ElectroLycra on stretching.

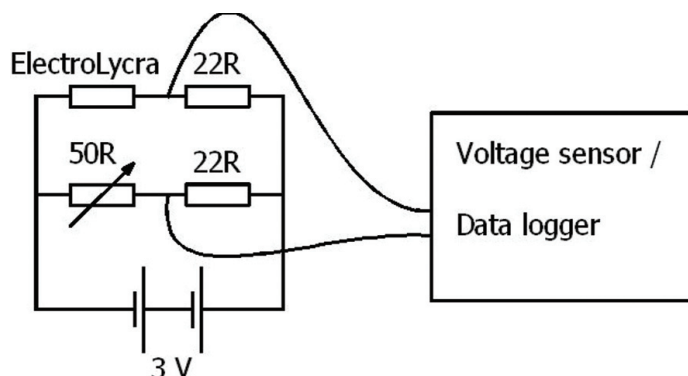

Figure 10 - Wheatstone Bridge circuit with ElectroLycra as sensor, 22Ω resistors and 50Ω variable resistor.

References

- [1] ElectroLycra - http://www.mutr.co.uk/product_info.php?products_id=1009614
- [2] elastic - <http://www.supplydivision.co.uk/elastic.htm#Double>

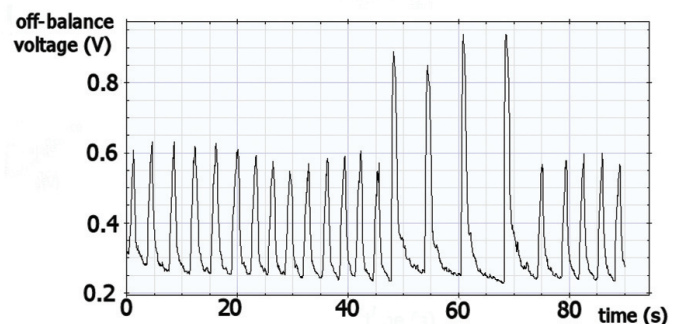

Figure 12 - Off-balance voltage against time – the graph shows normal breathing at the start, followed by deep breathing for 20 s.

falling out of the pocket. Attach two strips of Velcro to each side of the belt as shown in Figure 8. Make sure the Velcro is attached on the top of one side and on the bottom of the other side so when the belt is put on the strips of Velcro stick to each other.

The ElectroLycra's resistance changes with length as shown in Figure 9. It forms a branch of a Wheatstone Bridge as shown in Figure 10.

The change in length of the ElectroLycra is detected by measuring the off-balance voltage in the Wheatstone bridge using a voltage sensor connected to a data logger.

Put the belt around your chest so it fits tightly enough to stretch the ElectroLycra to about 6 cm, see Figure 11. The ElectroLycra must be operating in the range of stretching between 6 cm and 7 cm to give the best response. Connect the leads measuring the off balance voltage to the voltage sensor. If necessary adjust the variable resistor to get the output voltage to about 0.1 V. Typical graphs of breathing are shown on the laptop on Figure 11 and the graph of Figure 12.