

Heated Clothing – technical guide

Electrolycra® is made from stretchable cloth that has been sprayed with silver. This makes it into a conducting fabric. A current can pass through it, causing the material to warm up. It is supplied in long strips. Strips for experimentation should be cut from the supplied material as shown.

Referring to Figure 1, we will call the direction the scissors are pointing in the “length” of the strip, and the direction at right angles to this the “width”.

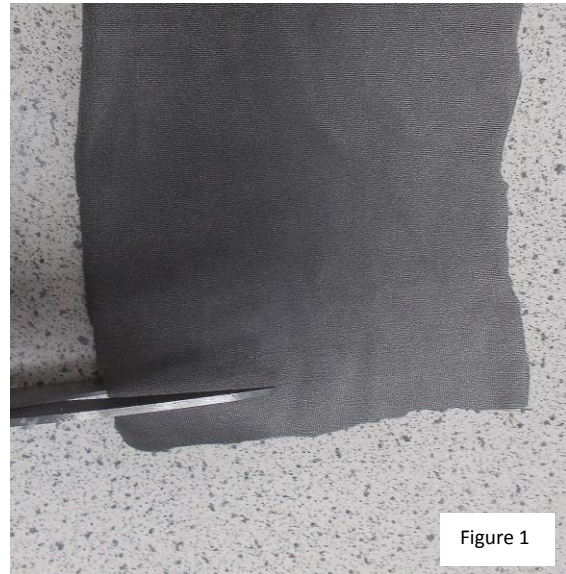

One strip is shown in Figure 2. The top of the material is where the cut was made. As a later microscope image will show, the weave of the fabric is not the same in the length and width directions.

The fabric is easier to stretch in the length direction compared with the width direction.

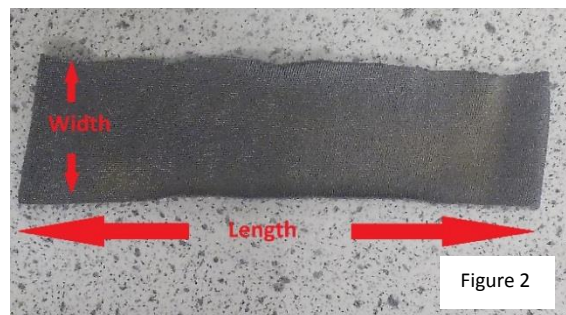

Resistance and stretch

The pictures in Figure 3 were taken using a digital microscope. They show what happens to the fabric when it is stretched.



Stretch

Figure 3

A property of Electrolycra is that, when stretched, its resistance increases but if stretched further, resistance falls. This refers to stretching in the “length” direction.

We believe the behaviour of resistance with stretch can be explained as follows. The current in the above picture travels left to right. As the material is stretched (first and second picture), the threads get further apart. There are fewer routes for a current to take, so resistance increases. As the material is stretched further, the threads bunch together, forming more paths for current, so the resistance falls.

When we stretched the Electrolycra in a direction perpendicular to the one shown (what we called the “width” direction), there was no initial rise in resistance. Resistance fell as stretched width increased.

Results are shown below.

The results in Table A are for a strip of width 64 mm stretched in the “length” direction (Figure 4).

Stretched length of strip (mm)	Resistance (ohms)
115	5.11
120	7.78
125	8.01
130	8.92
135	9.05
140	8.92
145	8.85
150	8.26
155	7.83
160	7.31
165	6.93
170	6.55
175	6.17
180	6.52

Table A

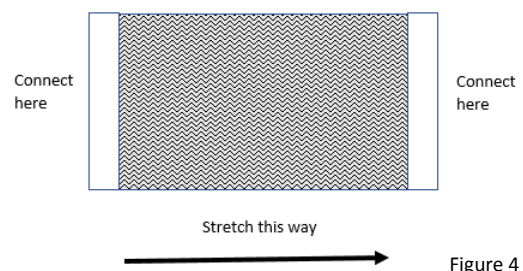

Figure 4

The results in Table B are for a strip of length 100 mm stretched in the “width” direction (Figure 5).

Stretched width of strip (mm)	Resistance (ohms)
70	1.41
80	0.92
90	0.73
100	0.66
110	0.62

Table B

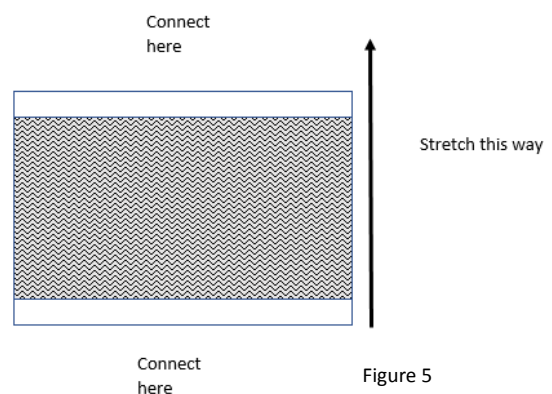

Figure 5

It is possible to connect electrically to the fabric using croc clips (Figure 6). This may not be the best method, particularly if investigating the effect of width on resistance. We stuck a strip of Electrolycra to a sheet of thermochromic film. This film changes colour when warmed. We would expect Electrolycra to be warmest where the current was greatest.



As can be seen in Figure 7, the heating effect is not even, leading to the conclusion that the current is not so either.

For this reason, we used “bulldog” clips to connect to the fabric.

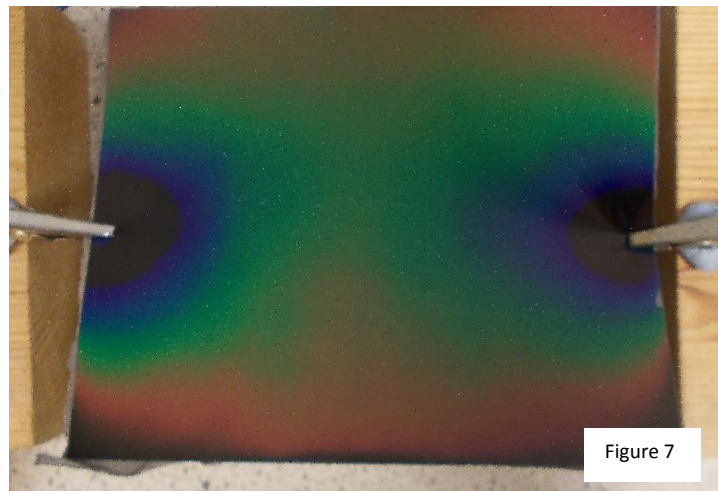

The bulldog clips (Figure 8) were chosen to be at least as wide as the strip of fabric that was being investigated. For the length investigation, the Electrolycra was clamped at one end. The other bulldog clip was free to be moved along the strip so that readings of resistance could be taken at different distances from the zero point.



Resistance and length, resistance and width

Using this set up, we were able to investigate the relationships between length of fabric and resistance. Theory suggests that resistance should be proportional to length. A graph of resistance versus length should be a straight line through the origin.

We also cut strips of the same length and different widths to investigate the relationship between width and resistance. Theory suggests that as long as each strip has the same thickness, the wider the strip, the lower its resistance. Going further, resistance should be inversely proportional to width. A graph of resistance versus $1/\text{width}$ should be a straight line through the origin.

Note that all the other components in the circuit – leads, clips etc – will have resistances. When we carried out our investigations, first of all we connected the clips together with no Electrolycra in place. This allowed us to obtain an estimate for the resistance of all the wires and connectors in the circuit. This could then be subtracted from all the resistances we measured. We then knew the resistance of the Electrolycra alone.

Results are shown below. Table C shows resistance versus length, Table D resistance versus width.

The same strip of Electrolycra was used throughout the length experiment. One contact was fixed at one end and another was moved along the strip to give different lengths between the contacts. The strip width was 10 mm.

Length (mm)	Resistance (ohms)
10	4.3
20	7.6
30	12.3
40	17.7
50	23.8
60	29.8
70	35.1
80	38.8
90	42.4

Table C

For the width experiment, a piece of Electrolycra of width 150 mm was gently stretched a few times then widths of 10, 20, 30, 40 and 50 mm were cut. All were the same length. Bulldog clips were used to connect each strip to an ohmmeter. The resistance of each strip was then found.

Width (mm)	Resistance (ohms)
10	25.7
20	10.6
30	7.5
40	4.7
50	3.3

Table D

Pre-stretching the Electrolycra and cutting adjacent strips was necessary. If this was not done, results could be inconsistent.

Rather than measuring resistance with an ohmmeter, a potential divider could be used (Figure 9).

Suppose that:

R_F is a known, fixed resistance (we used 220 Ω)

R_L is the resistance of the Electrolycra (what we're trying to find out)

V_F is the voltage across the fixed resistance

V_L is the voltage across the Electrolycra

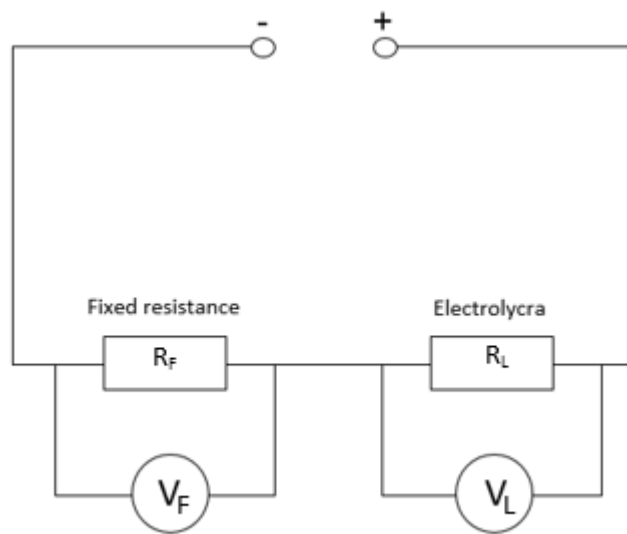

Figure 9

R_L can be found from the equation $\frac{R_L}{R_F} = \frac{V_L}{V_F}$

Does the resistance of Electrolycra depend on voltage?

If we know the voltage V across an object and the current I through it, we can calculate the resistance from:

$$\text{resistance} = \frac{V}{I}$$

For some objects

$$\frac{V}{I} = \text{constant}$$

(At least at the kind of voltages we would use in the lab).

For others, for example filament light bulbs and LEDs, this is not the case. For filament lamps, the filament gets hotter at larger voltages, causing the resistance to increase. LEDs have a “switch on voltage” below which the current is close to zero. This is due to the materials used in the LED and its construction.

We tried this investigation using a variable power supply to pass a current through the Electrolycra. An ammeter and voltmeter were connected in the usual way to measure the current through the Electrolycra and the voltage across it. If resistance does not change with voltage, a graph of current versus voltage should give a straight line.

Safety warning! If the current is allowed to become too large, the Electrolycra may catch fire.

Results are shown in Table E.

Current (A)	Voltage (V)
0.04	0.17
0.07	0.35
0.12	0.58
0.19	0.87
0.27	1.26
0.35	1.61
0.47	2.15
0.56	2.52
0.65	2.85
0.76	3.23
0.84	3.44
1.04	4.06
1.32	4.78
1.47	5.00
1.74	5.54

Table E

We also tried this experiment over a range of small currents. The results are shown in Table F.

Current (A)	Voltage (V)
0.018	0.077
0.019	0.082
0.020	0.087
0.021	0.092
0.022	0.097
0.023	0.101
0.024	0.106
0.025	0.111
0.026	0.115
0.027	0.120

Table F

Current and temperature

The relationship between current and temperature can be investigated.

We used a square of Electrolycra about 50 mm x 50 mm. We tried an alternative method of connecting to it using car repair mesh.

We expected temperature to increase as current increased.

We also investigated the Stefan-Boltzmann Law, which states:

P is proportional to $(T^4 - T_0^4)$

Where P is the power radiated from the object, T is its Kelvin temperature and T_0 is the Kelvin temperature of its surroundings.

We assumed the radiated power was the same as the electrical power input to the Electrolycra. We calculated this by connecting a voltmeter across the Electrolycra to measure V and an ammeter in series with the fabric to measure I . We then used the following equation:

$$P = V \times I$$

We tried different methods to find temperature. All were successful.

The methods were:

A small temperature probe taped to the Electrolycra;

An infrared thermometer (the kind you point at an object without touching it);

A thermal imaging camera (Figure 10) which gives a readout of the temperature of the part of an object indicated by crosshairs in the display.

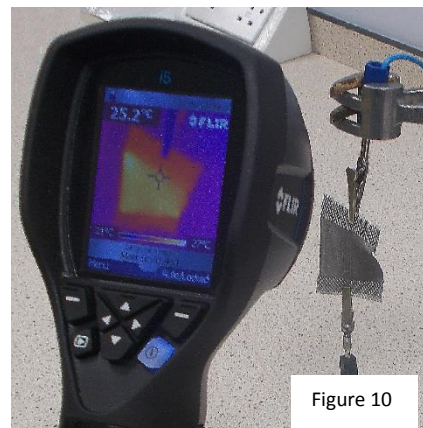

Figure 10

Safety warning! If the current is allowed to become too large, the Electrolycra may catch fire.

If P is proportional to $(T^4 - T_0^4)$, a graph of $(T^4 - T_0^4)$ versus P should be a straight line through the origin.

Results are shown in Table G:

V (V)	I ₁ (A)	I ₂ (A)	I ₃ (A)	I ₄ (A)	I ₅ (A)	T ₁ (°C)	T ₂ (°C)	T ₃ (°C)	T ₄ (°C)	T ₅ (°C)
0.00	0.00	0.00	0.00	0.00	0.00	24.2	25.3	25.5	25.4	25.5
0.50	0.12	0.18	0.17	0.16	0.15	25.5	26.8	26.8	26.7	26.6
1.00	0.23	0.36	0.34	0.32	0.30	27.9	30.3	30.4	30.1	30.0
1.50	0.39	0.53	0.52	0.48	0.44	32.1	37.1	36.4	35.5	34.7
2.00	0.65	0.77	0.70	0.64	0.61	41.6	46.2	44.3	42.5	40.7
2.50	0.88	1.00	0.94	0.87	0.78	51.5	58.3	54.6	51.9	48.6
3.00	1.22	1.36	1.22	1.11	0.99	65.9	73.7	68.7	63.4	58.3
3.50	1.62	1.62	1.44	1.38	1.22	87.2	89.1	82.0	78.0	70.7

Table G

Note that we repeated the experiment 5 times for each voltage, then took averages of current and temperature.

Notes

When we investigated Electrolycra, we uncovered some evidence that it may contract slightly when heated. This in turn can alter the resistance.